

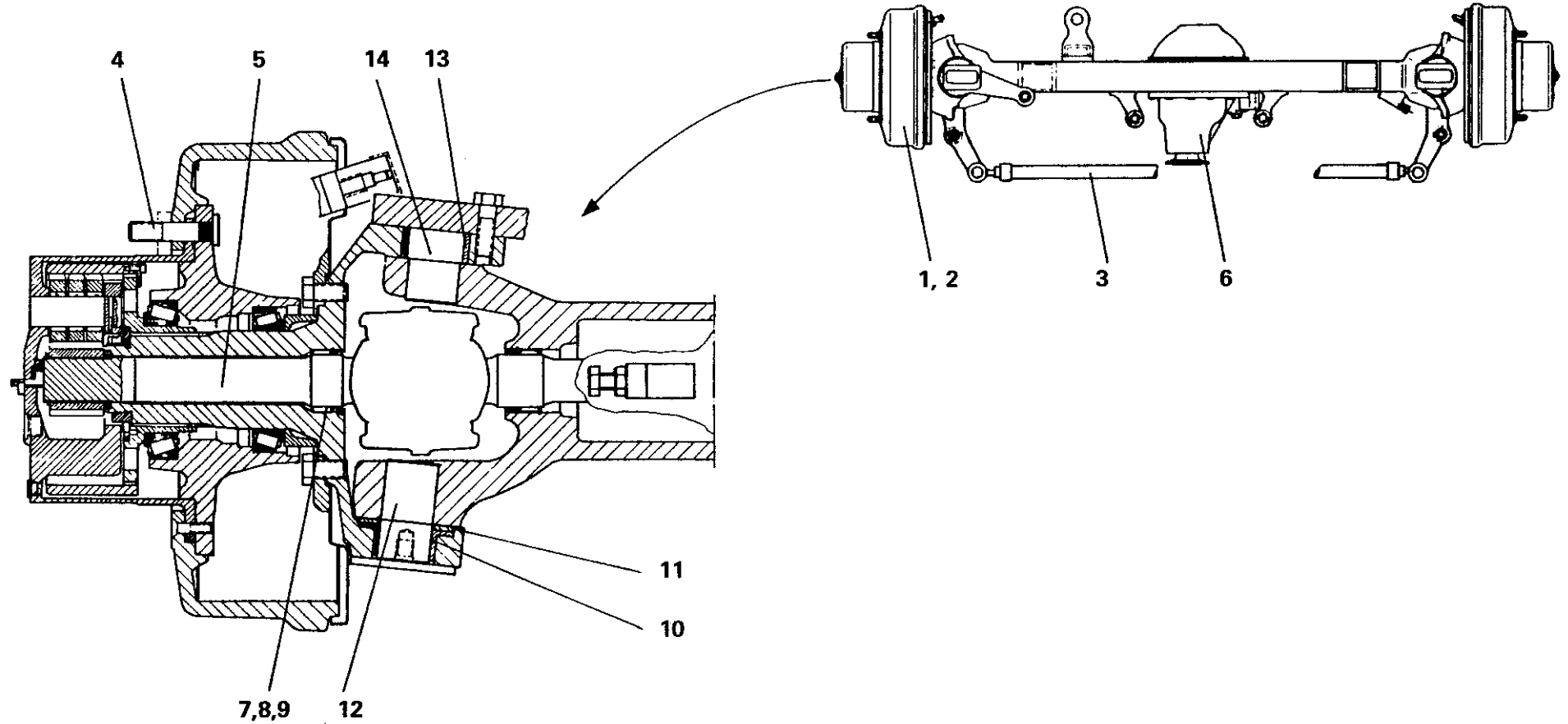

LENKTRIEBACHSE
STEERED AND DRIVEN AXLE

ERSATZTEIL - BILDTAFEL
SPARE PART - PICTORIAL DISPLAY



Bildtafel-Nr. 2 222 390
Pictorial display No.

1 377 963 -ETL

FHG 13